

HF105F-2

MINIATURE HIGH POWER RELAY



File No.:E134517



File No.:40025518



File No.:CQC09002031229(DC type)



Features

- 40A switching capability
- Heavy load up to 7,200VA
- PCB coil terminals, ideal for heavy duty load
- Wash tight and dust protected types available
- Class F insulation available
- Environmental friendly product (RoHS compliant)
- Outline Dimensions: (32.4 x 27.5 x 27.8)mm

CONTACT DATA

Contact arrangement	1A	1B	1C (NO)	1C (NC)
Contact resistance	50mΩ (at 1A 24VDC)			
Contact material	AgSnO ₂ , AgCdO			
Max. switching capacity	7200VA/560W	3600VA/280W	4800VA/560W	2400VA/280W
Max. switching voltage	277VAC/28VDC			
Max. switching current	40A	15A	20A	10A
HF105F-2 rating	30A 240VAC 20A 28VDC	15A 240VAC 10A 28VDC	20A 240VAC 20A 28VDC	10A 240VAC 10A 28VDC
HF105F-2L rating	25A 240VAC 20A 28VDC	15A 240VAC 10A 28VDC	20A 240VAC 20A 28VDC	10A 240VAC 10A 28VDC
Mechanical endurance	1 x 10 ⁷ OPS			
Electrical endurance	1 x 10 ⁵ OPS ¹⁾ (See approval reports for more details)			

CHARACTERISTICS

Insulation resistance	1000MΩ (at 500VDC)	
Dielectric strength	Between coil & contacts	2500VAC 1min
	Between open contacts	1500VAC 1min
Operate time (at nomi. volt.)	15ms max.	
Release time (at nomi. volt.)	10ms max.	
Ambient temperature	DC: -55°C to 85°C AC: -55°C to 60°C	
Shock resistance	Functional	98m/s ²
	Destructive	980m/s ²
Vibration resistance	10Hz to 55Hz 1.5mm DA	
Humidity	98%RH, 40°C	
Termination	PCB & QC	
Unit weight	Approx. 36g	
Construction	Wash tight, Dust protected	

- Notes:** 1) Typical electrical load & endurance: at 30A 240VAC, Resistive, at room temperature, 100,000 OPS, for NO contact, remove vent nib after soldering and cleaning.
2) The data shown above are initial values.
3) Please find coil temperature curve in the characteristic curves below.

COIL

Coil power	DC type: Approx.900mW; AC type: Approx.2VA
------------	---

SAFETY APPROVAL RATINGS

UL/ CUL	1 Form A	AgSnO ₂	30A 277VAC	
		AgCdO	2HP 250VAC 1HP 125VAC	
	1 Form B	AgCdO	30A 28VDC 277VAC(FLA=20)(LRA=60)	
		AgCdO	15A 277VAC 10A 28VDC 1/2HP 250VAC 1/4HP 125VAC 277VAC(FLA=10)(LRA=33)	
	1 Form C	NO	AgSnO ₂	30A 277VAC
			AgCdO	2HP 250VAC 1HP 125VAC
NC		AgCdO	20A 277VAC 20A 28VDC 277VAC(FLA=20)(LRA=60)	
		AgCdO	20A 277VAC 1/2HP 250VAC 1/4HP 125VAC 10A 277VAC 10A 28VDC 277VAC(FLA=10)(LRA=33)	

Notes: Only some typical ratings are listed above. If more details are required, please contact us.



HONGFA RELAY

ISO9001, ISO/TS16949, ISO14001, OHSAS18001, IECQ QC 080000 CERTIFIED

2010 Rev. 1.00

COIL DATA

at 23°C

Nominal Voltage VDC	Pick-up Voltage VDC	Drop-out Voltage VDC	Max. Allowable Voltage VDC	Coil Resistance Ω
5	3.75	0.5	6.5	27 x (1±10%)
6	4.50	0.6	7.8	40 x (1±10%)
9	6.75	0.9	11.7	97 x (1±10%)
12	9.00	1.2	15.6	155 x (1±10%)
15	11.25	1.5	19.5	256 x (1±10%)
18	13.50	1.8	23.4	380 x (1±10%)
24	18.00	2.4	31.2	660 x (1±10%)
48	36.00	4.8	62.4	2560 x (1±10%)
70	52.50	7.0	91	5500 x (1±10%)
110	82.50	11	143	13450 x (1±10%)

Nominal Voltage VAC	Pick-up Voltage VAC	Drop-out Voltage VAC	Max. Allowable Voltage VDC	Coil Resistance Ω
12	9.6	2.4	15.6	25 x (1±10%)
24	19.2	4.8	31.2	100 x (1±10%)
120	96.0	24.0	156	2500 x (1±10%)
208	166.4	41	270.4	11000 x (1±10%)
220/240	192	48	286	13490 x (1±10%)
277	220	54	360.1	15000 x (1±10%)

Notes: 1) When requiring pick-up voltage < 80% of nominal voltage, special order allowed.
2) The data shown above are initial values at 50Hz. When requiring 60Hz, special order allowed.

ORDERING INFORMATION

Type		HF105F-2: 30A HF105F-2L: 25A		HF105F-2 / 018 D -1H S T F (XXX)	
Coil voltage		DC: 5VDC to 110VDC AC: 12VAC to 277VAC			
Coil voltage form		D: DC A: AC			
Contact arrangement		1H:1 Form A 1D:1 Form B 1Z:1 Form C			
Construction ¹⁾		S: Wash tight Nil: Dust protected			
Contact material		T: AgSnO ₂ Nil: AgCdO			
Insulation standard		F: Class F Nil: Class B			
Customer special code					

Notes: 1) We recommend dust protected types for a clean environment (free from contaminations like H₂S, SO₂, NO₂, dust, etc.).

We suggest to choose wash tight types and validate it in real application for an unclean environment (with contaminations like H₂S, SO₂, NO₂, dust, etc.).

If water cleaning is required after the relay is assembled on PCB, please contact us for suggestion about suitable parts.

2) To avoid using relays under strong magnetic field which will change the parameters of relays such as pick-up voltage and drop-out voltage.

3) Relays may be damaged because of falling or when shocking conditions exceed the requirement.

4) Regarding the wash tight relay, we should leave it cooling naturally until below 40°C after welding, then clean it and deal with coating, remarkably the temperature of solvents should also be controlled below 40°C. Please avoid cleaning the relay by ultrasonic, avoid using the solvents like gasoline, Freon, and so on, which would affect the configuration of relay or influence the environment.

5) About preferable condition of operation, storage and transportation, please refer to "Explanation to terminology and guidelines of relay".

1 Form A

Outline Dimensions

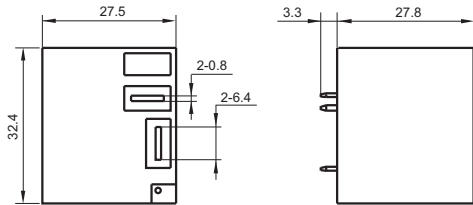

Wiring Diagram

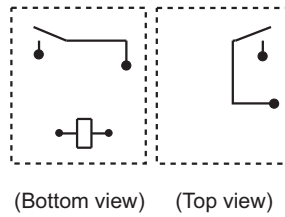

PCB Layout
(Bottom view)

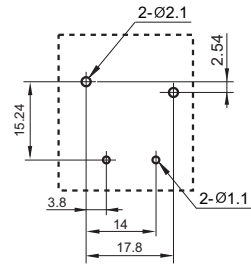

1 Form B

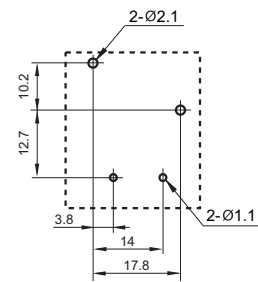
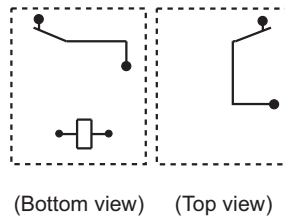
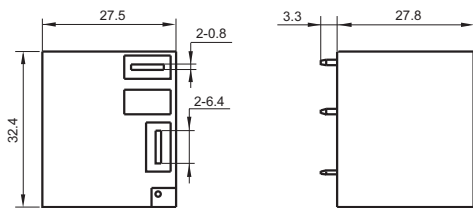

1 Form C

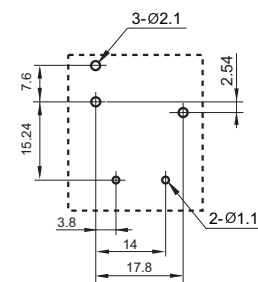
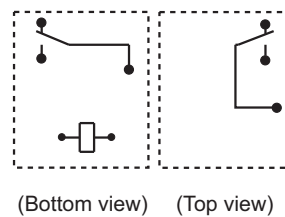
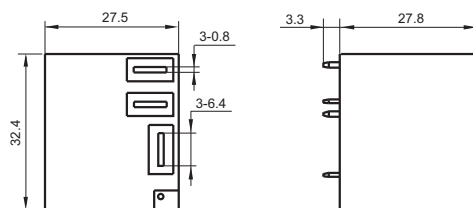

- Remark: 1) In case of no tolerance shown in outline dimension: outline dimension $\leq 1\text{mm}$, tolerance should be $\pm 0.2\text{mm}$; outline dimension $> 1\text{mm}$ and $\leq 5\text{mm}$, tolerance should be $\pm 0.3\text{mm}$; outline dimension $> 5\text{mm}$, tolerance should be $\pm 0.4\text{mm}$.
 2) The tolerance without indicating for PCB layout is always $\pm 0.1\text{mm}$.

CHARACTERISTIC CURVES

MAXIMUM SWITCHING POWER

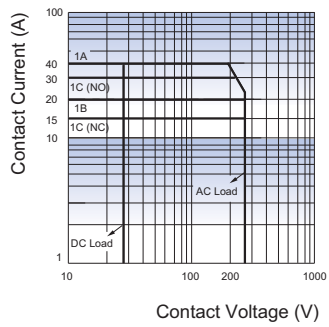

ENDURANCE CURVE

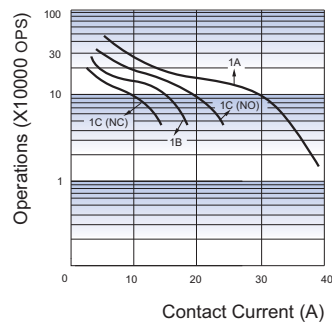

COIL TEMPERATURE RISE

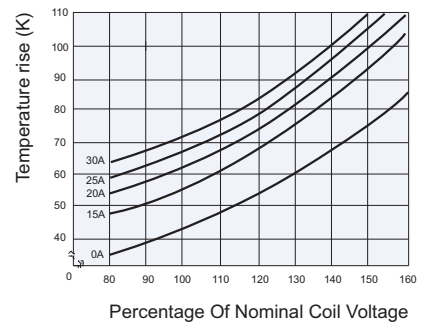

Disclaimer

This datasheet is for the customers' reference. All the specifications are subject to change without notice.

We could not evaluate all the performance and all the parameters for every possible application. Thus the user should be in a right position to choose the suitable product for their own application. If there is any query, please contact Hongfa for the technical service. However, it is the user's responsibility to determine which product should be used only.

© Xiamen Hongfa Electroacoustic Co., Ltd. All rights of Hongfa are reserved.